

LARGE DRAWER ASSORTMENTS

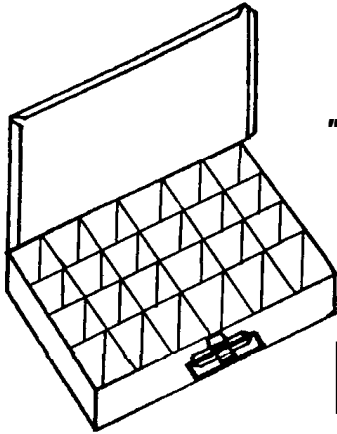

LARGE "STEEL DRAWER" ASSORTMENTS

18" HIGH x 12" DEEP
x 3" HIGH

WE OFFER A WIDE
VARIETY OF PROFESSIONAL
ASSORTMENTS IN HIGH QUALITY
"LARGE" STEEL DRAWERS.

PRE-PRINTED LID LABELS ALLOW
FOR EASY RE-ORDERING OF EVERY
BSF PART NUMBER.



Assortment No. AST - 4004

Metric Body Hardware

21 Items - 210 Pieces



 1712	 1897	 1108	 1107
 1678	 1111	 1110	 1112
 2011	 1113	 1711	 1687
 1116	 1117	 1118	 1119
 1120	 1122	 1123	 1124



Assortment No. AST - 4001

Special Plastic Retainers

24 Items - 198 Pieces



 1012	 1013	 1692	 1974	 1661	 1650
 1972	 1977	 1651	 1652	 1689	 1976
 1690	 1010	 1659	 1657	 1691	 1008
 1654	 1655	 2064	 2009	 1923	 1008



Assortment No. AST - 4018

Special Plastic Retainers

24 Items - 258 pieces



























 1001	 1002	 1631	 1632	 1633	 1003
 1634	 1636	 1637	 1639	 1640	 1978
 1643	 1635	 1644	 1662	 1919	 1645
 1646	 1648	 1641	 1649	 1007	 1656



































LARGE DRAWER ASSORTMENTS

































Assortment No. AST - 4023
Japanese Import Fasteners - #1
 24 Items - 183 pieces

					
1967	1747	1983	2026	1896	1745
					
1746	1968	1752	2025	1590	1740
					
1893	2080	1975	1748	1749	1695
					
1594	1664	1984	1971	1969	1719























Assortment No. AST - 4024
Japanese Import Fasteners - #2
 32 Items - 217 pieces

							
2031	2082	1606	1607	1700	1701	1603	1602
							
1706	1707	2065	2066	2067	1742	1982	1663
							
1698	2068	1579	1580	1581	1582	1693	1979
							
1660	1980	1696	1981	1717	1697	1658	1751

Assortment No. AST - 4030
Japanese Import Fasteners - #3
 32 Items - 213 pieces

							
1920	2087	1900	1899	1898	1902	1989	1667
							
1934	1909	1991	1992	1567	1990	1569	1988
							
1913	1910	1563	2069	1574	2070	1575	1917
							
1577	1578	1921	1987	1916	2083	1592	1593



















Assortment No. AST - 4052
Assorted Metal Fasteners
 22 Items - 238 pieces

					
1290	1291	1292	2001	1294	
					
1167	1168	1169	1170	1160	1314
					
1161	1162	1163	1164	1165	1315
					
	1317	1318	1914	1915	1316























LARGE DRAWER ASSORTMENTS































Assortment No. AST - 4011
Standard Rivets
 19 Items - 375 Pieces

 1668	 1340	 1341	 1895
 1350	 1929	 1351	 1930
 1718	 1927	 1928	 1355
 1356	 1986	 1357	 1358
	 1672	 1363	 1365































Assortment No. AST - 4025
Specialty Rivets
 20 Items - 175 Pieces

 1985	 1911	 1903	 1669
 1933	 1708	 1709	 1670
 1361	 1362	 1908	 1671
 1380	 1381	 1932	 1891
 1892	 1382	 1383	 1710

Assortment No. AST - 4012
Phillips Sheet Metal Screws
 31 Items - 461 pieces

 1278	 1279	 1716	 1675	 1676	 1997		 2000
 1171	 1240	 1241	 1250	 1251	 1998	 2063	 1280
 1173	 1174	 1175	 1177	 1194	 1195	 1216	 1218
 1219	 1220	 1211	 1213	 1214	 1230	 1231	 1232





















Assortment No. AST - 4013
Specialty Screws
 31 Items - 414 pieces

 1905	 1906	 1907	 2039	 1281	 1677	 1924	
 1999	 1715	 2088	 1714	 2037	 1925	 1283	 1282
 1270	 1271	 2089	 2032	 2033	 2034	 2035	 2036
 1273	 1274	 1284	 2038	 1285	 2040	 1272	 1275











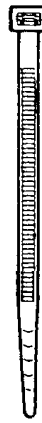



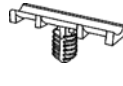

LARGE DRAWER ASSORTMENTS



































Assortment No. AST - 4050
Plastic Clips & License Plate Fasteners
 24 Items - 258 pieces

 1063	 1064	 1067	 1068	 1066	 1894
 1071	 1069	 1062	 1741	 1703	 1653
 1299	 1922	 1939	 2024	 1937	 2079
 1994	 1995	 1996	 1044	 1047	 1046

Assortment No. AST - 4053
Cable Ties & Wire Loom Clips
 14 Items - 130 pieces

 1373	 1769	 1713	 1931	 2003	 1665
				 2004	 1374
				 2005	 1375
				 2006	 2008
		 2002	 2007		

Assortment No. AST - 4014
Electrical Connectors & Fuses
 34 Items - 236 pieces

 ATM-7.5	 ATM-10	 ATM-15	 ATM-20	 ATM-25	 ATM-30	 1414	 1416	 1418
 ATO-7.5	 ATO-10	 ATO-15	 ATO-20	 ATO-25	 ATO-30	 1420	 1421	 1422
 1400	 1401	 1402	 1403	 1404	 1405	 1406	 1408	
 1409	 1410	 1412	 1411	 1413	 1423	 1424	 1425	

Assortment No. AST - 4055
*Heat Shrink * Crimp & Seal Terminals*
 22 Items - 120 pieces

 2054	 2057	 2055	 2058	 2056	 2059
 2041	 2042	 2043	 2044	 2045	 2046
 2047	 2048	 2049	 2050	 2051	 2052
 2053	 2060	 2060	 2061	 2061	 2062



LARGE DRAWER ASSORTMENTS

Assortment No. AST - 4021
Mini-Bulbs - Smaller Sizes
 32 Items - 95 pieces

67	5007	5008	74	24A	24	194A	194
3021	906	906A	912	916	916A	921	922
3175	3423	212-2	211-2	7440A	7440	7443A	7443
561	3496	3497	7506	7528	7507A	17640	7225

Assortment No. AST - 4022
Mini-Bulbs - Larger Sizes
 21 Items - 67 pieces

1156	1156NA	1157	1157NA
2057	2057NA	1295	1295A
5702AK			
3057	3057NA	3156	3156NA
3157	3157NA	3457	3457NA
3757AK	4114K	4157LLNA	4157LL

Assortment No. AST - 4051
Halogen Lamps
 24 Items - 24 Pieces

H-1	H-3	891	2040	9145 (H-10)	880	881
884	885	886	889	890	893	
	9003	9004	9005			
9006	9007	9008 (H-13)	H-4			
H-7	H-8	H-9	H-11			

Assortment No. AST - 5509
Basic Automotive Bulbs
 25 Items - 90 pieces

194	24	24A	906A	7440	7443	1157
194A	916	922	7440A	7443A	1157A	
1156	3057	3457	4157LL	3156	3157	
1156A	3057A	3457A	4157LLA	3156A	3157A	



LARGE QUICK - KITS

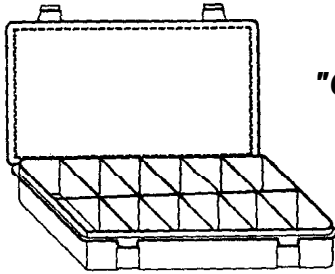

LARGE "CLEAR PLASTIC" QUICK - KITS

13" WIDE x 9" DEEP
x 2-5/16" HIGH

PORTABLE, DURABLE AND ECONOMICAL,
OUR LARGE QUICK-KITS ARE DESIGNED
TO OFFER A WIDE VARIETY OF POPULAR
ITEMS IN WELL ORGANIZED
"POLYPROPYLENE" PLASTIC BINS.

QUICK - KIT # L-138 Specialty Plastic Fasteners 12 Items - 130 Pieces					
1633	1002	1003	1649	1007	1656
1012	1974	1651	1689	1972	1650

QUICK - KIT # L-134 Import Push-In Retainers 18 Items - 120 Pieces					
1967	1747	1983	2026	1896	1745
1968	1752	2025	1590	1748	1749
1740	1984	1971	1969	1695	1719













QUICK - KIT # L-133 Specialty Import Fasteners 24 Items - 130 Pieces					
2031	1606	1700	1701	1602	1706
2067	1742	1663	1579	1979	1660
1697	1899	1898	1902	1992	1569
1916	1987	1989	1917	1988	1667













QUICK - KIT # L-137 Metric Body Hardware 16 Items - 120 Pieces			
1114	1687	1116	1117
1119	1120	1122	1123
1712	1107	1108	1687
1113	2011	1111	1110

















QUICK - KIT # L-142 Mini Bulbs 18 Items - 50 Pieces					
194	916NA	7440	7443	1156	1157
194NA	922	7440NA	7443NA	1156NA	1157NA
3156	3156NA	3157	3157NA	3457	3457NA

















LARGE QUICK - KITS





QUICK - KIT # L-136 Standard Rivets 12 Items - 230 Pieces					
 1340	 1341	 1350	 1351	 1718	 1895
 1927	 1928	 1355	 1356	 1357	 1358

QUICK - KIT # L-135 Specialty Rivets 12 Items - 100 Pieces					
 1668	 1985	 1911	 1669	 1908	 1671
 1933	 1708	 1709	 1670	 1986	 1361

QUICK - KIT # L-139 Specialty Screws 16 Items - 200 Pieces			
 1279	 1998	 1675	 1676
 1999	 1714	 1280	 2000
 1282	 1283	 2036	 2035
 1270	 1284	 1285	 1272

QUICK - KIT # L-132 Heat Shrink * Crimp & Seal Terminals 22 Items - 120 Pieces					
 2054	 2057	 2055	 2058	 2056	 2059
 2041	 2042	 2043	 2044	 2045	 2046
 2047	 2048	 2049	 2050	 2051	 2052
 2053	 2060	 2060	 2061	 2061	 2062



















QUICK - KIT # L-114 Cable Ties & Wire Loom Clips 8 items - 100 pieces	
 1373	 1374
 1769	
 1713	 2002
 1931	 2003
	 2004

QUICK - KIT # L-131 Plated Flat Washers 12 Items - 160 Pieces					
 1542	 1479	 1480	 1481	 1482	 1483
 1473	 1468	 1469	 1470	 1471	 1472











LARGE QUICK - KITS

















QUICK - KIT # L-108
Speed Nuts & Barrel Clips
18 Items - 192 Pieces

 1303	 1304	 1305	 1306	 1307	 1308
 1309	 1311	 1312	 1166	 1167	 1168
 1169	 1170	 1160	 1161	 1162	 1163









QUICK - KIT # L-140
Air-Saw * Sawzall Blades
9 Items - 16 Pieces

 M318	 M324	 M332
 M418		 M424
 M618		 M624
 M814		







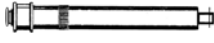



QUICK - KIT # L-105
Door Hinge Bushings
18 Items - 62 Pieces

 1722	 1754	 1720	 1759
 1721	 1726	 1727	 1753
 1723	 1725	 1724	 1956
 1957	 1761 / 1762	 1763	 1959 / 1960

QUICK - KIT # L-104
GM Door Hinge Pins
9 items - 21 pieces

 1890	 1731	 1730
 1733		 1732
 1755	 1963	 1965
 1958		

QUICK - KIT # L-112
Door Hinge Pins - Other
10 items - 24 pieces

 1758	 1760	 1964	 1728	 1729	 1756
 1966			 1961	 1962	 1757



SMALL QUICK - KITS

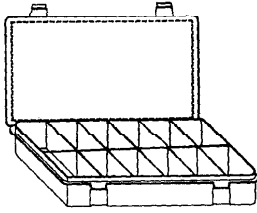

SMALL "CLEAR PLASTIC" QUICK - KITS

11" WIDE x 6-3/4" DEEP
x 1-3/4" HIGH

OUR SMALL QUICK-KITS OFFER EASY ACCESS
AND ORGANIZATION OF MANY SPECIALIZED
FASTENER ITEMS IN "SMALLER SIZE"
POLYPROPYLENE BINS.

S-501 - Automotive Fuses					
18 items - 60 pieces					
ATM-2	ATM-3	ATM-4	ATM-5	ATM-7.5	ATM-10
ATM-15	ATM-20	ATM-25	ATM-30	ATO-3	ATO-5
ATO-7.5	ATO-10	ATO-15	ATO-20	ATO-25	ATO-30

S-502 - Electrical Connectors					
18 items - 100 pieces					
1400	1401	1402	1405	1408	1410
1412	1411	1413	1414	1416	1418
1420	1421	1422	1423	1424	1425

S-515 - License Plate Fasteners					
12 items - 160 pieces					
1071	1922	1299	1939	2027	2028
2075	2076	2024	2078	2079	2029

S-511 - Jack Nuts, Well Nuts, Screws					
17 items - 51 pieces					
1943	1945	1944	1942	1301	1941
1948	1949	1950	1946	1947	
1951	1954	1955	1302	1952	1953















S-510 - Door Hinge Bushings					
12 items - 36 Pieces					
1722	1754	1720	1759	1721	1726
1727	1753	1723	1725	1724	1761



















S-512 - Toyota/Lexus Moulding Clips					
12 items - 100 Pieces					
2012	2013	2014	2015	2016	2017
2018	2019	2020	2021	2022	2023

S-514 - Air-Saw Blades					
6 items - 12 pieces					
M318	M324	M332	M418	M424	M432



SMALL QUICK - KITS

 S-507 - Self-Drilling "Tek" Screws  12 items - 136 Pieces					
 1765	 1766	 1679	 1767	 1680	 1681
 1716	 1684	 1685	 1686	 1682	 1683

 S-516 - Weatherstrip & Trim Clips  18 items - 180 pieces					
 1631	 1632	 1633	 1001	 1636	 1921
 2031	 2082	 1606	 1701	 1700	 1602
 1707	 1603	 1706	 1741	 1703	 1653

 S-507 - Low Profile Mini Fuses  7 items - 35 Pieces			
 LPM-5	 LPM-7.5	 LPM-10	 LPM-15
 LPM-20		 LPM-25	 LPM-30